

Counting Scale

CS Series

OWNER'S MANUAL









CONTENTS

PRECAUTIONS	4
PREFACE	6
NAMES AND FUNCTIONS	6
OPERATIONS	8
1. When You Know the Number of the Samples	8
2. When You Know the Unit of the Samples	9
3. Checking the Defined Quantity	9
4. How to Use Tare Function	11
5. Computing Error Alarm	13
SPECIFICATIONS	14

PRECAUTIONS

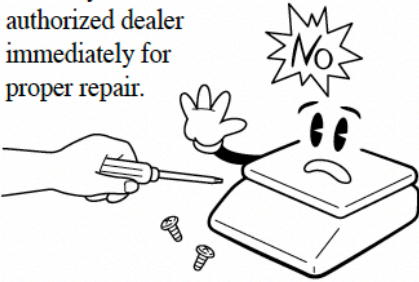
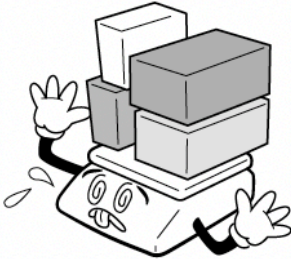
**Make sure that you plug your scale into the proper power outlet.
Plug into a power outlet 30 minutes before operations.**

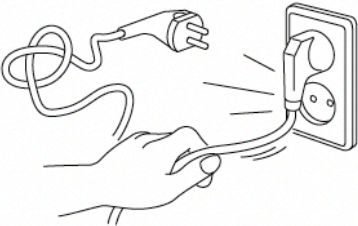
⚠ Warning

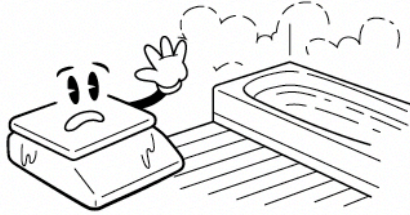
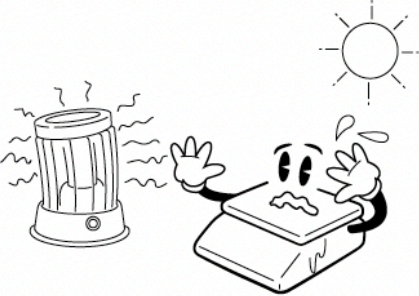
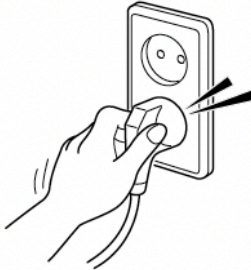
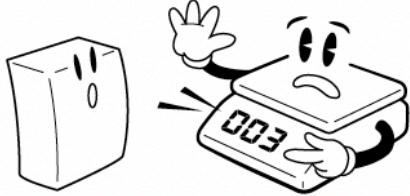
<p>Do not disassemble the scale. When any damage or defect occurs, contact your CAS authorized dealer immediately for proper repair.</p> 	<p>Do not overload beyond the maximum weight limit.</p> 	<p>Scale must be grounded to minimize electricity static. This will minimize defect or electric shock.</p> 
<p>Do not pull the plug by its cord when unplugging. Damaged cord could cause electric shock or fire.</p> 	<p>To prevent from fire occurring, Do not place or use the scale near flammable or corrosive gas.</p> 	<p>To reduce electric shock or incorrect reading, Do not spill water on the scale or place it in humid condition.</p> 
<p>Avoid placing the scale near heater or in direct sunlight.</p> 	<p>Insert plug firmly to wall outlet to prevent electric shock.</p> 	<p>For consistent and accurate reading, maintain periodical check by your CAS authorized dealer.</p> 

 Attention

Place the scale on firm and temperature consistent environment.



Avoid sudden shock to the scale. Internal mechanism could be damaged.



Grab on the bottom of the scale when moving. Do not hold by the platter.



Keep the scale away from other electromagnetic generating devices. This may interfere with accurate reading.



By adjusting 4 corners of the scale, set the scale even using the built in scale leveling indicator.



PREFACE

Thank you for the purchasing of our CAS CS Series.

These series has been designed with CAS reliability, under rigid quality control and with outstanding performances. Your departments can enjoy with this high quality reliable CAS product.

This electronic load cell scale eliminates all the moving parts and furnish an accurate digital display of all the information. We believe that your needs will be satisfied and you will have reliability with in variable weight.

This manual will help you with proper operations and care of the CS series. Please keep it handy for the future references.

NAMES AND FUNCTIONS

OVERALL VIEW

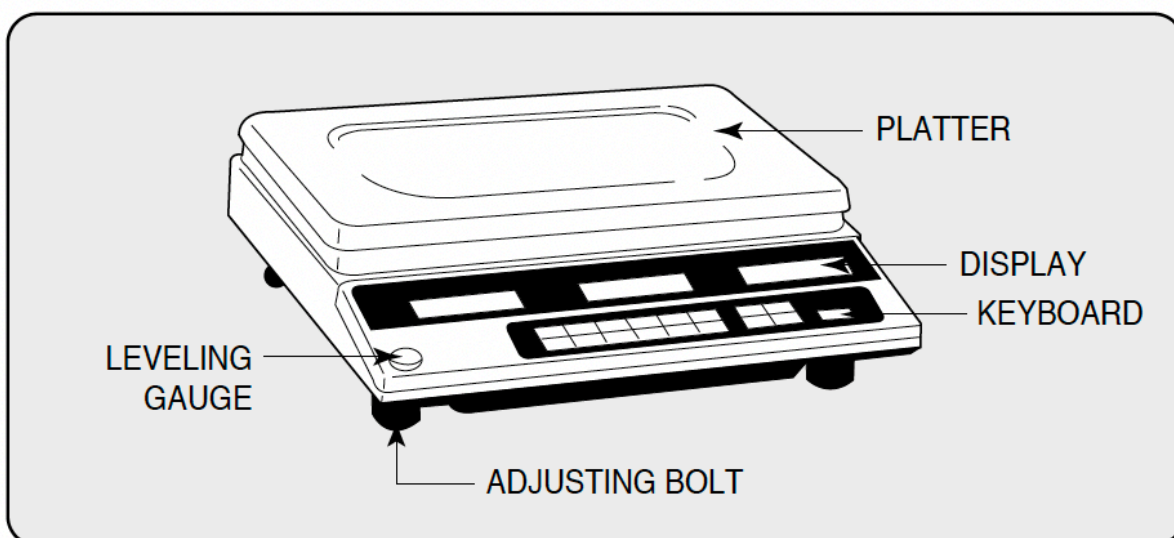

DISPLAY & KEYBOARD

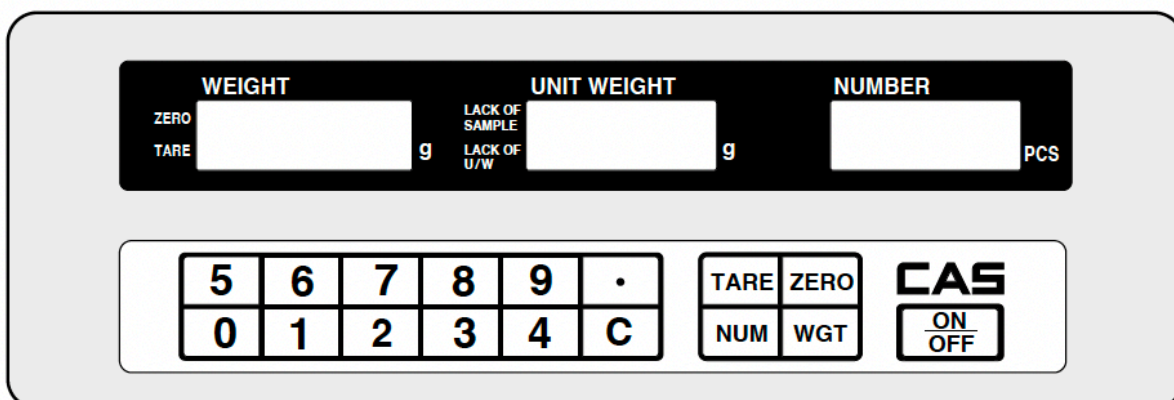

WEIGHT DISPLAY

- This display shows the weight of the sample on the platter.
- When the tare removed from the platter, display shows the tare weight with "-".
- If the weight exceeds the maximum capacity of the scale, display will show O-L and you will hear a beep sound.
- The ◀ symbol represents the lamps on the displays.
ZERO Lamp: If the ZERO lamp is on, it means that weight is zero.
TARE Lamp: If the TARE lamp is on, it means that tare is entered.







UNIT WEIGHT DISPLAY

- This display shows the unit weight of the sample or recorded sampling quantities.
- Lack of Sample: This lamp blink when the sample is lacked.
- Lack of U/W: This lamp blink when unit weight is smaller then set value.

NUMBER DISPLAY

- This display shows the number of the sample.

■ FUNCTION

KEYS	FUNCTIONS
	Numeric keys used to enter numerical data.
	Used to enter the unit weight with decimal point.
	Clear key used to clear recorded unit weight or recorded quantity.
	When you know the number of the samples, you can know the unit weight by pressing this key.
	When you know the unit weight, you can know the number of the samples by pressing this key.
	Used to set the ZERO point.
	Used to clear TARE entries and to enter TARE weight.

KEYS	FUNCTIONS
	Turns the display on or off. Set all displays to ZERO.

OPERATIONS

Plug the scale into an AC socket and make sure that the socket's power is within the scale's operating range.

The scale count up to 9's and you will hear a beep.

Check the power voltage.

►NOTE: Plug into a power outlet 10 minutes before operations.

1. When You Know the Number of the Samples

- When you know the number of the samples, you can use this method.
- Make sure that ZERO lamp is on.

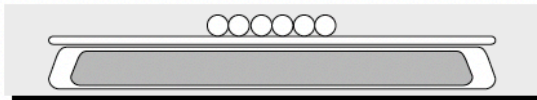

① Place the samples on the platter.

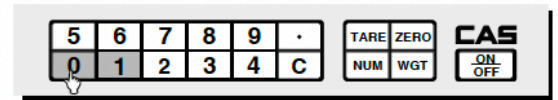
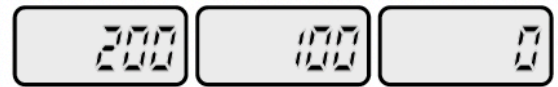

② Enter the number of the samples with the numeric keys.

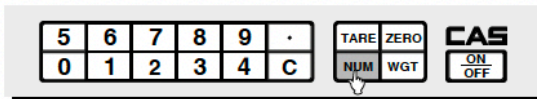

③ Press the NUM key, then Unit Weight display will show the unit weight sample.

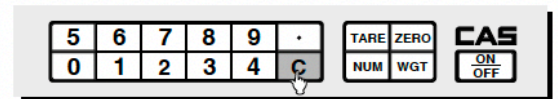

④ Remove the samples and press the C key.

► CSH Type :If the number of sample exceeds 100,000 units the unit weight display shows "----" with beeps. Please remove the sample from the platter and press C key to clear previous transaction.

CS Type :If the number of sample exceeds 100,000 units, maximum displaying limit nothing shows up on the display.

2. When You Know the Unit Weight of the Samples

- When you know the unit weight of the samples, you can use this method.
- Make sure that ZERO lamp is on.

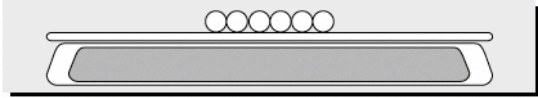

① Place the samples on the platter.

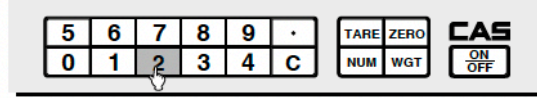

② Enter the unit weight.

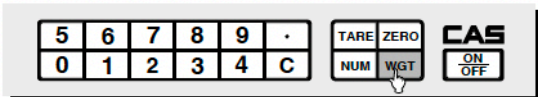

③ Press the WGT key, then the Number display will show the number of the samples.

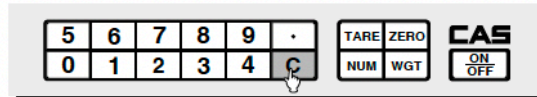

④ Remove the samples and press the C key.

3. Checking the Defined Quantity

If the number of samples exceed the defined quantity, the display will blink with an alarm. This function helps unit packaging of quantity checking.

A) CS Type



① Press "." key 3 times.

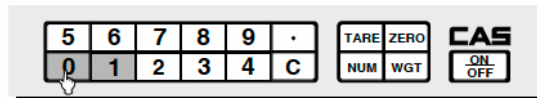
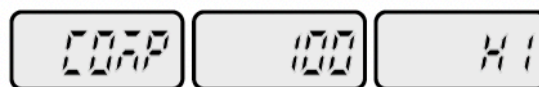

② Enter the defined quantity. If you want to change the defined quantity, press the C key and enter the defined quantity again.

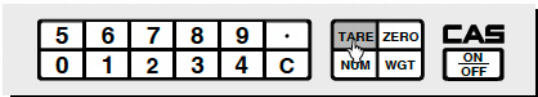

③ Press the TARE key. Then the defined quantity is entered.

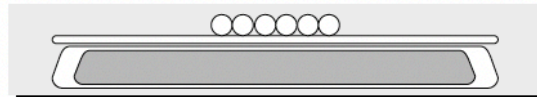

④ Place the samples on the platter.

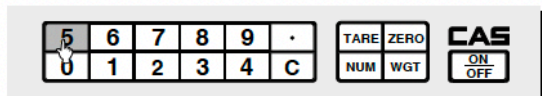

⑤ Enter the unit weight.

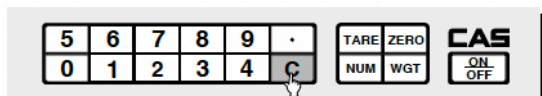

⑦ Remove the samples from the platter and press the C key.

B) CSH Type

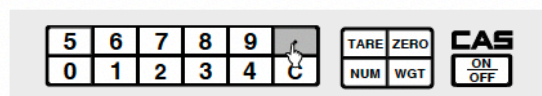

① Press . key 3 times.

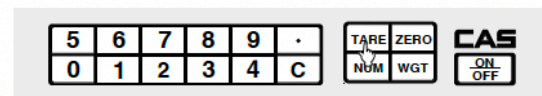

② Press TARE key to go to HIGH limit of sample quantity mode.

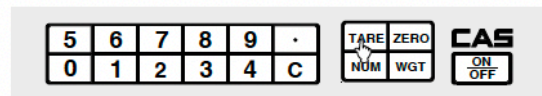

⑤ Press TARE key to input HIGH limit of sample quantity, and then automatically go to normal mode.

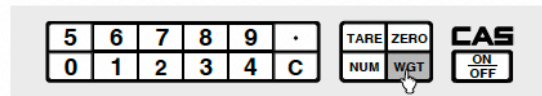

⑥ Press the WGT key. If these samples exceed the defined quantity, the number will flicker in the Number display.

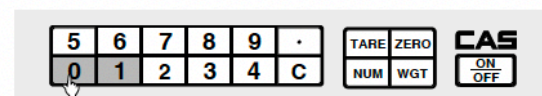

③ Set the LOW limit of sample quantity.

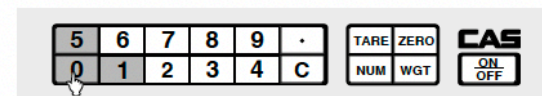
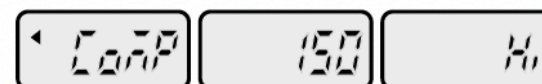

④ Set the HIGH limit of sample quantity.

- Quantity of sample \leq LOW limit set \rightarrow Number blinks on the display.
- Quantity of sample \geq HIGH limit set \rightarrow Number blinks on the display with beep.
- To get out of this mode, press the \cdot key three times and press the C key and the TARE key.

4. How to Use Tare Function

- Tare is the weight of a container from real weight on the platter.
- The TARE key subtracts the weight of the container.

A) Unknown Tare

- If you do not know the weight of the container, you may use this method.
- Make sure that ZERO lamp is on.



① Place the container on the platter.

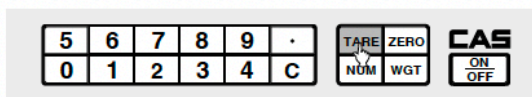

② Press the TARE key.



③ Place the sample in the container. Display will show only weight of the sample.

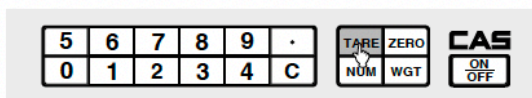

④ Remove the container and press the TARE key.

B) Known Tare

- If you know the weight of the container you may use this method.
- Make sure that ZERO lamp is on.

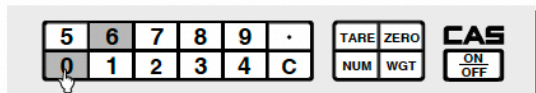
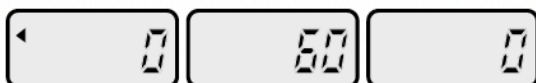

① Enter the weight of the container.

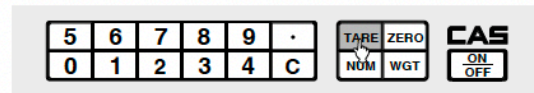

② Press the TARE key.

- NOTE: In case of 2.5CS, if the weight of the container is 10g, you have to type 100(①). Because the weight of the container is displayed as 10.0g in the weight display(②). If the weight of the container is 20.5g, you have to type 205, then the weight display shows the 20.5g.

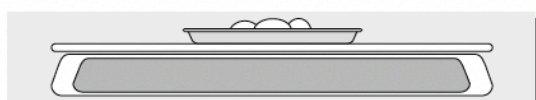

③ Place the sample with container on the platter.

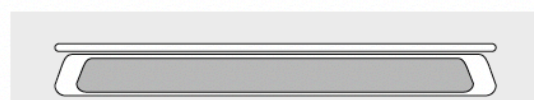

④ Remove the sample with container from the platter.

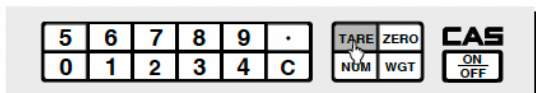

⑤ Press the TARE key to remove tare function.

TABLE 1. Range of the Tare Weight

MODEL	MAX. WEIGHT	MAX. TARE WEIGHT	MIN. WEIGHT
2.5CS	2.5kg	999.5g	0.5g
5CS	5kg	1,999g	1g
10CS	10kg	3,998g	2g
25CS	25kg	9,995g	5g
CS-05H	5kg	4,999.5g	0.5g
CS-10H	10kg	9,999g	1g
CS-20H	20kg	19,998g	2g

5. Computing Error Alarm

This scale has an alarm function for too light sample unit.
This function shows the possibility of calculating errors.

Sample Weight Lack Alarm

- If sample weight is within the range of sample weight lack,
(Refer to TABLE 2) Lack of Sample lamp will blink (with beep in CS model).

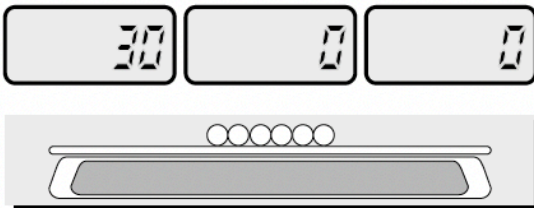

① Place the samples on the platter.

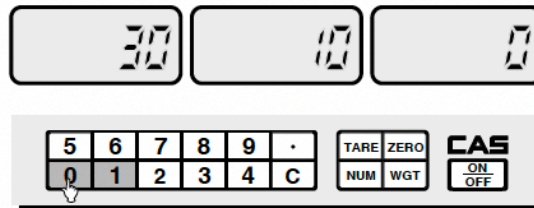

② Enter the number of the samples.

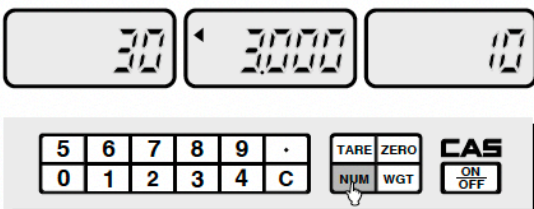

③ To know the unit weight, press the NUM key.
Lack of sample lamp blinks.

For example, this scale is 10CS, so 30g is within the range of sample lacking.
(Refer to TABLE 2) In this case, Lack of Sample lamp will be flickered. Until the flickering disappears, increase the sample weight. Unit weight can be changed and the number of samples will be calculated automatically.

Unit Weight Lack Alarm

- If unit weight is within the range of unit weight lack, Lack of unit weight lamp will be flickered. (Refer to TABLE 2)

TABLE 2. Range of the sample & unit weight lack.

MODEL	MAX. WEIGHT	RANGE OF SAMPLE WEIGHT LACK	RANGE OF UNIT WEIGHT LACK
2.5CS	2.5kg	0 – 12.5g	0 – 0.25g
5CS	5kg	0 – 25g	0 – 0.5g
10CS	10kg	0 – 50g	0 – 1g
25CS	25kg	0 – 125g	0 – 2.5g
CS-05H	5kg	0 – 25g	0 – 0.25g
CS-10H	10kg	0 – 50g	0 – 0.5g
CS-20H	20kg	0 – 100g	0 – 1g

SPECIFICATIONS

MODEL (CS Type)	2.5 CS	5CS	10CS	25CS
CAPACITY	2.5kg X 0.5g	5kg X 1g	10kg X 2g	25kg X 5g
MAXIMUM TARE WEIGHT	999.5g	1,999g	3,998g	9,995g
LACKING RANGE OF SAMPLE	0 – 12.5g	0 – 25g	0 – 50g	0 – 125g
LACKING RANGE OF U/W	0 – 0.25g	0 – 0.5g	0 – 1g	0 – 2.5g
FUNCTION	Unit Weight, Weight, Quantity			
DIGITS on DISPLAY	5 / 5 / 5			
OPERATING TEMPERATURE	-10°C ~ +40°C			
POWER SOURCE	AC 220V / 50Hz			
POWER CONSUMPTION	Approximately 10W			
PRODUCT SIZE (mm)	350(W) X 325(D) X 105(H)			
PRODUCT WEIGHT	4.2kg			

MODEL (CSH Type)	CS-05H	CS-10H	CS-20H
CAPACITY	5 kg X 0.5 g	10 kg X 1 g	20 kg X 2 g
MAXIMUM TARE WEIGHT	4,999.5 g	9,999 g	19,998 g
LACKING RANGE OF SAMPLE	0~25 g	0~50 g	0~100 g
LACKING RANGE OF U/W	0~0.25 g	0~0.5 g	0~1 g
LAMP on DISPLAY	Zero, Tare, Lack of Sample, Lack of Unit Weight		
DIGITS on DISPLAY	5 / 5 / 5		
OPERATING TEMPERATURE	-10°C ~ + 40°C		
POWER	AC 220V / 60Hz		
POWER CONSUMPTION(W)	Approximately 10W		
PLATTER SIZE (mm)	340(W) X 215(D)		
PRODUCT SIZE (mm)	350(W) X 325(D) X 105(H)		
PRODUCT WEIGHT	5.3 kg		

► Notice: Specifications are subject to change for improvement without notice.

