

Counting Scale

AC-TYPE

OWNER'S MANUAL





CONTENTS

PRECAUTIONS	4
PREFACE	6
NAMES AND FUNCTIONS	6
INSTALLATION	9
OPERATIONS	10
1. When You Know the Number of the Samples	10
2. When You Know the Unit of the Samples	11
3. Checking the Defined Quantity	12
4. How to Use Tare Function	13
5. Computing Error Alarm	16
SPECIFICATIONS	17

PRECAUTIONS

Make sure that you plug your scale into the proper power outlet.
Plug into a power outlet 30 minutes before operations.

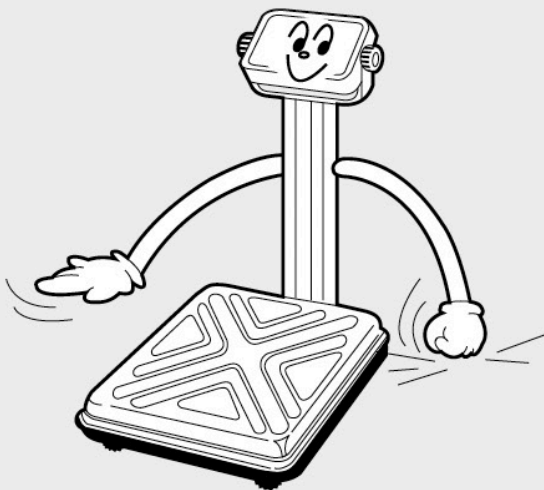

- Place the scale on a flat and stable surface.

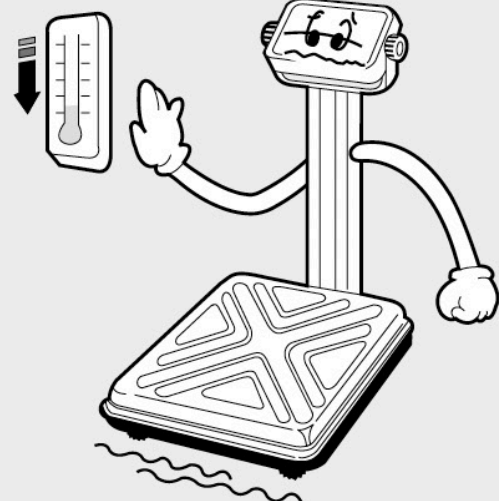

- Do not put the scale on a sudden temperature changes.

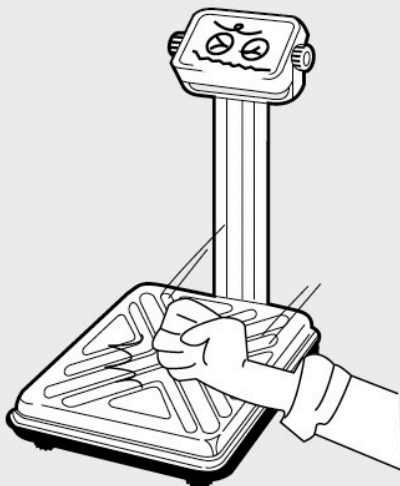

- Do not put the scale on a sudden impact to the platter.



- Keep away from the wet place.

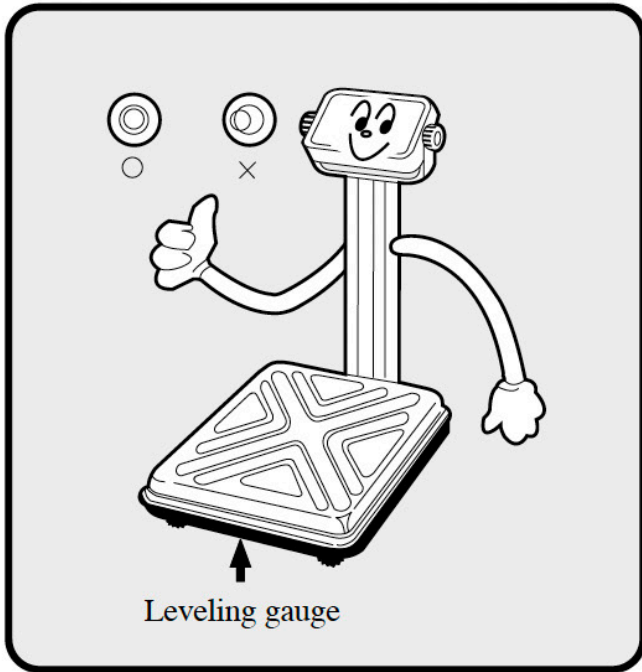

- **Leveling:** If the scale is not properly level, please adjust the 4 legs at the bottom of the scale (turn legs clockwise or counterclockwise) so as to center the bubble of the leveling gauge inside the indicated circle. Lift the platter, then you will see the leveling gauge.

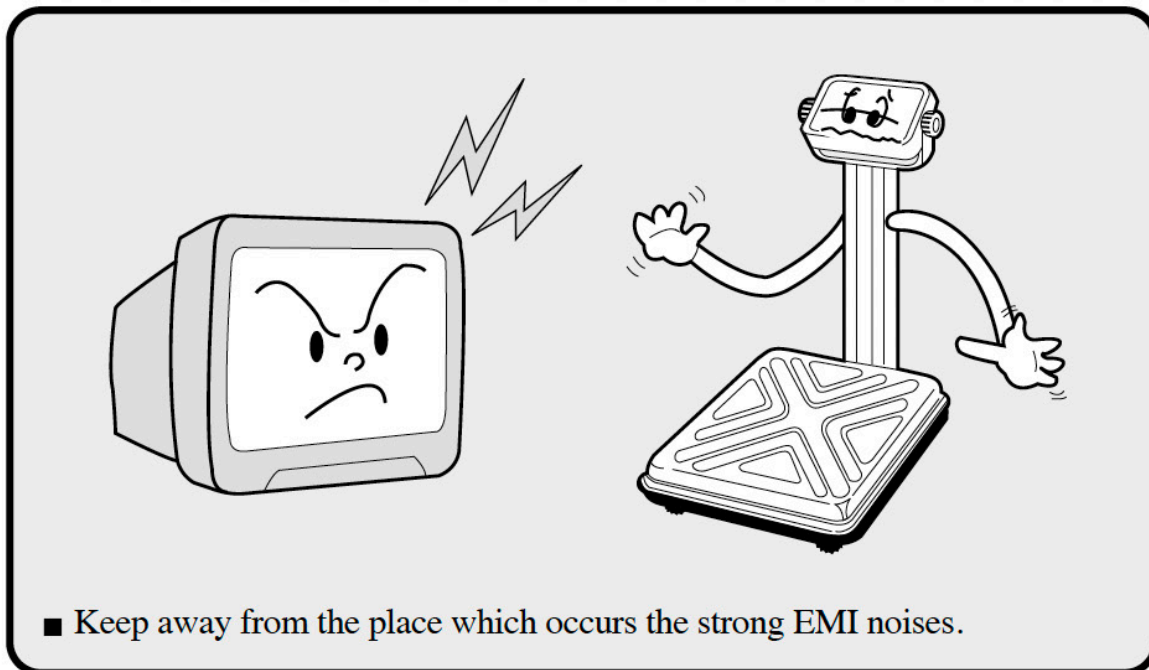

PREFACE

Thank you for the purchasing our CAS AC Series.

This series has been designed with CAS reliability, under rigid quality control and with outstanding performances, Your departments can enjoy with this high quality reliable CAS products.

This electronic load cell scale eliminates all the moving parts and furnish an accurate digital display of all the information. We believe that your needs will be satisfied and you will have proper reliability in variable weight. This manual will help you with proper operations and care of the AC Series.

Please keep it handy for the future references.

NAMES AND FUNCTIONS

OVERALL VIEW

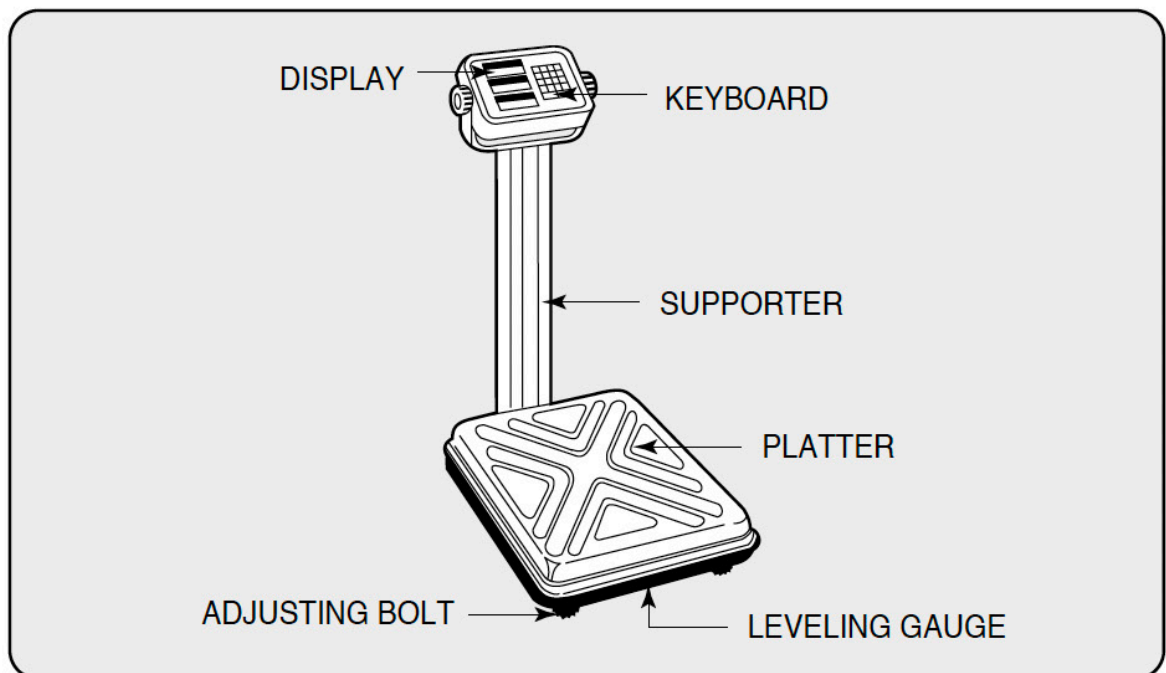

DISPLAY & KEYBOARD

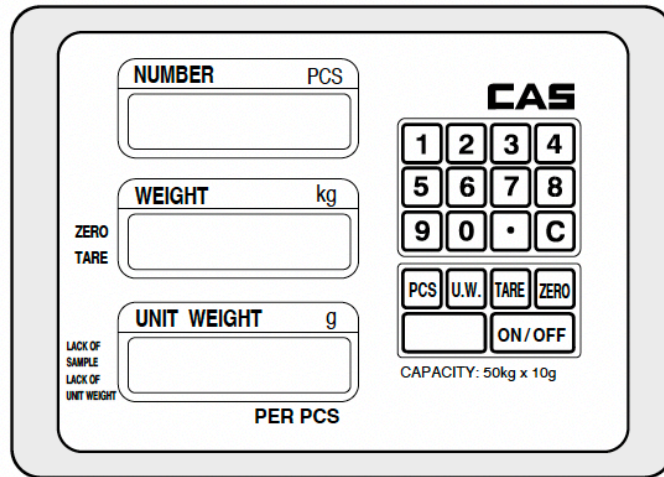

WEIGHT DISPLAY

- This display shows the weight of the sample on the platter.
- When the tare removed from the platter, display shows the tare weight with "-".
- If the weight exceeds the maximum capacity of the scale, display will show O-L and you will hear a beep sound.
- The ◀ symbol represents the lamps on the displays.
 ZERO Lamp: If the ZERO lamp is on, it means that weight is zero.
 TARE Lamp: If the TARE lamp is on, it means that tare is entered.

UNIT WEIGHT DISPLAY

- This display shows the unit weight of the sample or recorded sampling quantities.
- Lack of Sample: This lamp blink when the sample is lacked.
- Lack of Unit Weight: This lamp blink when unit weight is within the range of unit weight lack.







NUMBER DISPLAY

- This display shows the number of the sample.

■ FUNCTION

KEYS	FUNCTIONS
	Numeric keys used to enter numerical data.
	Used to enter the unit weight with decimal point.



KEYS	FUNCTIONS
	Clear key used to clear recorded unit weight or recorded quantity.
	When you know the number of the samples, you can get the unit weight by pressing this key.
	When you know the unit weight, you can get the number of the samples by pressing this key.
	Used to set the ZERO point.
	Used to clear TARE entries and to enter TARE weight.
	Turns the display on or off. Set all displays to Zero.

REAR PANEL

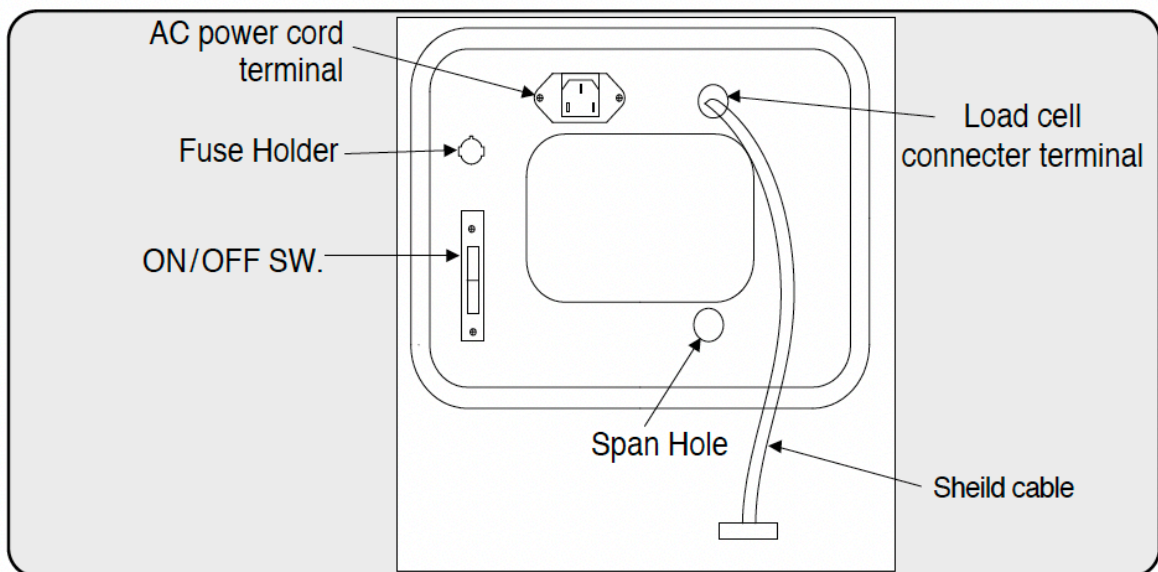

- **Fuse Holder** :Please change the fuse when the scale is not working at " ON" status in the case fuse is inside to protect the circuit.
- **AC power code junction terminal** : Please fully insert the AC power code when you use it.
- **Shield cable** : Please use this cable with support pole inserted to cabel hole after connecting connector of load cell cable and shield cable..

INSTALLATION

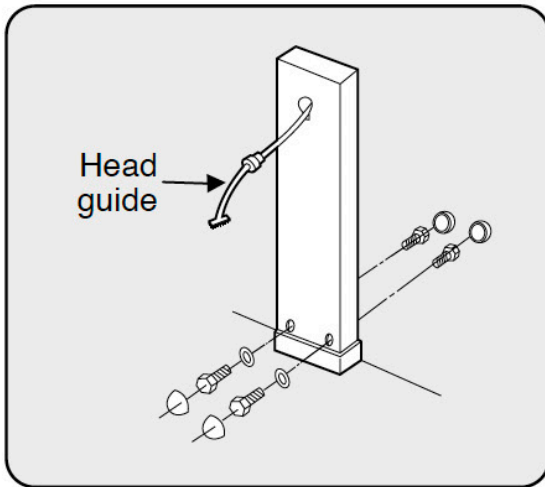

1. Fix with bolts and nuts after inserting the load cell cable to support pole. and then please fix the ground wire with a bolt and fix the bolt hat up it.

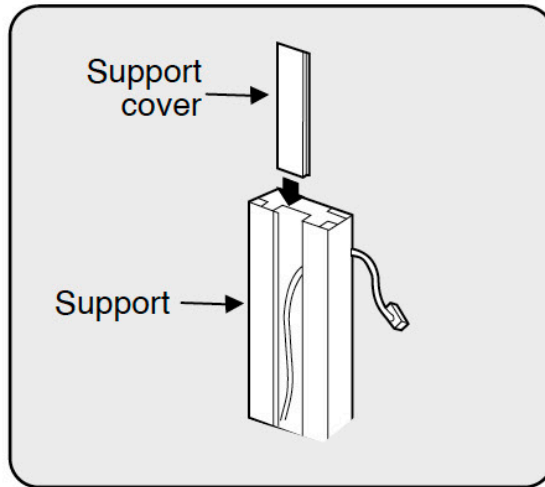

2. Please insert support cover into the support pole.

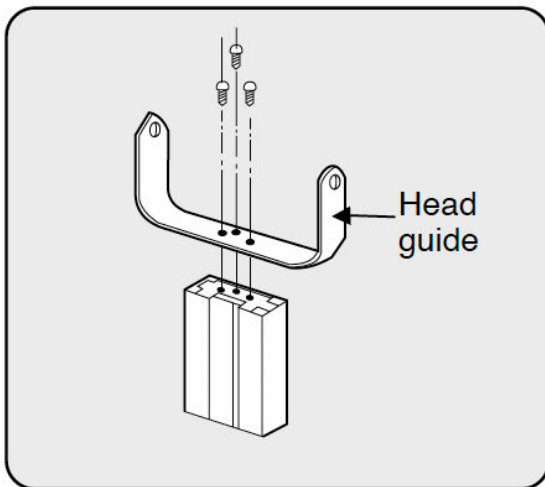

3. Please fix the head guide with bolt.

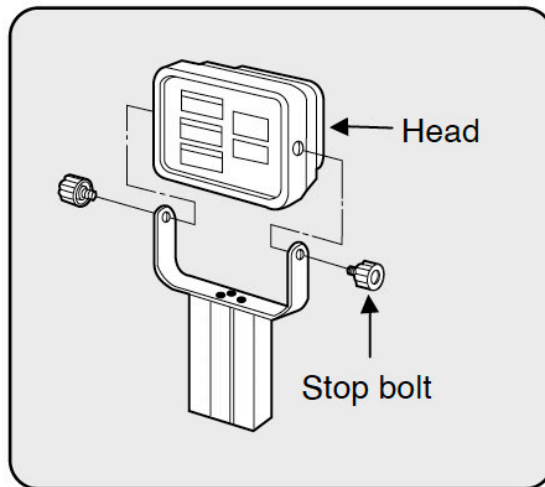

4. Please connect head part to Head guide and fix it with Stop bolt.

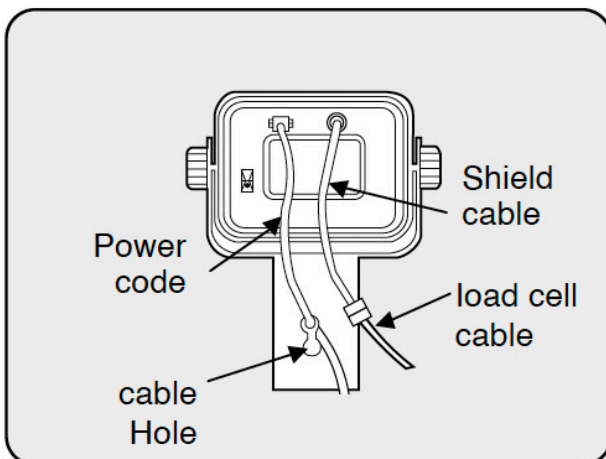

5. Please insert to support cable hole after connecting the load cell cable and shield cab Stick the power code to the back of the Head part.

OPERATIONS

- Insert load cell connector into the load cell terminal.
- Plug the scale into an AC socket and make sure that the socket's power is within the scale's operating range.
- Turn ON the power switch.
- Press ON/OFF key on the keyboard.
- The scale count up to 9's and you will hear a beep.

1. When You Know the Number of the Samples

- When you know the number of the samples, you can use this method.
- Make sure that ZERO lamp is on.

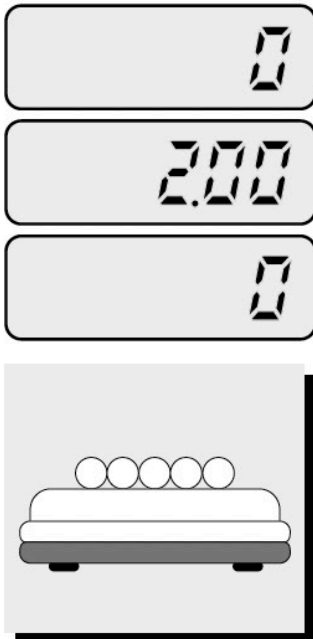

① Place the samples on the platter.

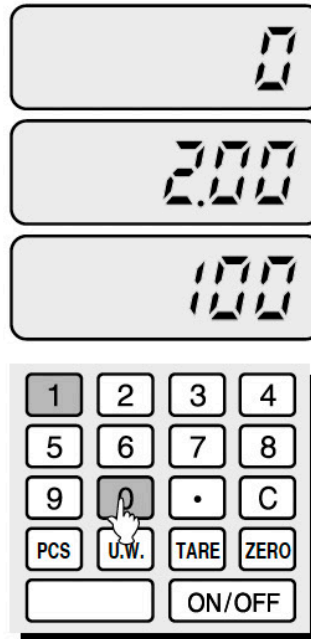

② Enter the number of the samples with the numeric keys.



③ Press the PCS key, then Unit Weight display will show the unit weight of sample.

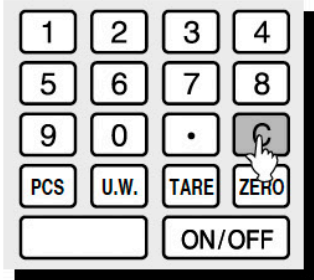
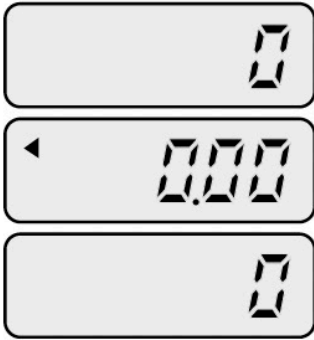

④ Remove the samples and press the C key.

► NOTE: If the Unit Weight display shows "-----", remove the samples and press the C key. In this case, it is impossible to know the unit weight.

2. When You Know the Unit Weight of the Sample

- When you know the unit weight of the sample, you can use this method.
- Make sure that ZERO lamp is on.

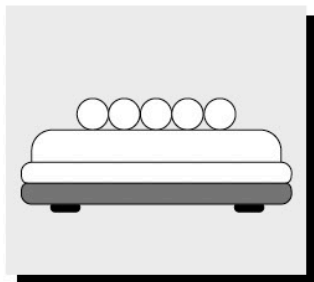

① Place the samples on the platter.

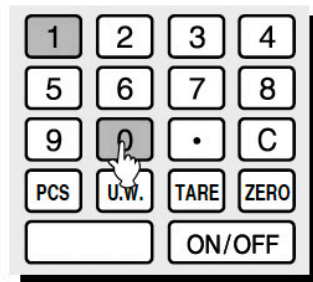

② Enter the unit weight.

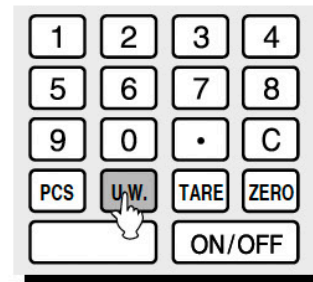

③ Press the U.W. key, then the Number display will show the number of the samples.

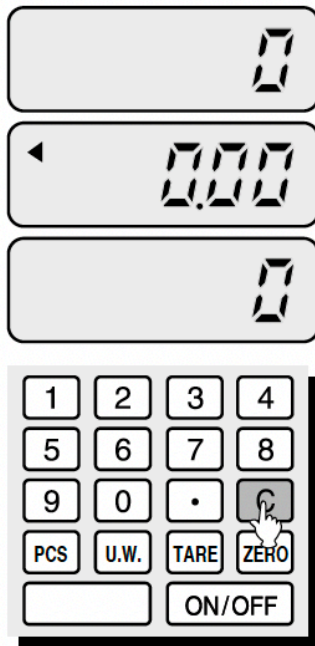

④ Remove the samples and press the C key.

3. Checking the Defined Quantity

If the number of samples exceed the defined quantity, the display will flicker with an alarm. This function helps unit packaging of quantity checking.

Make sure that the zero lamp should be on.



① Press " . " key 3 times.



② Enter the defined quantity that you wish to set. If you want to change the defined quantity, press the C key and enter the defined quantity again.

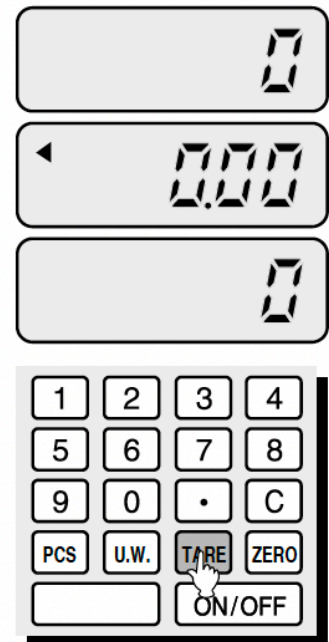

③ Press the TARE key. Then the defined quantity is entered.

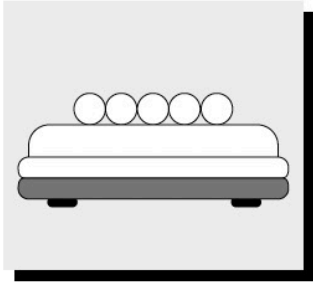
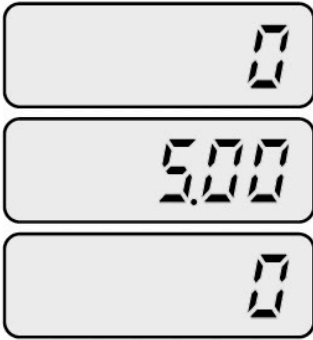

④ Place the samples on the platter.

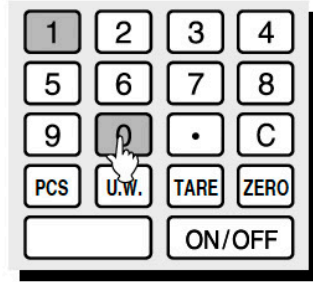

⑤ Enter the unit weight.

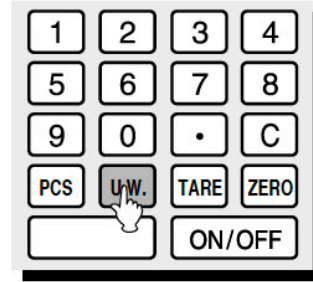

⑥ Press the U.W. key. If these samples exceed the defined quantity, the number will flicker in the Number display.

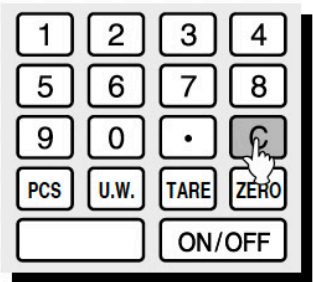
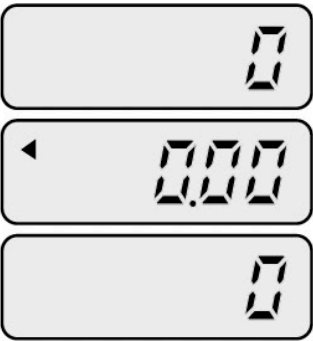

⑦ Remove the samples from the platter and press the C key.

► NOTE: To get out of this mode, follow these steps.

- ① press the C key
- ② press the \blacktriangleleft key three times
- ③ press the C key
- ④ press the TARE key.

4. How to Use Tare Function

- Tare is the weight of a container being used for a sample.
- The TARE key subtracts the weight of the container.

A) Unknown Tare

- If you do not know the weight of the container, you may use this method.
- Make sure that ZERO lamp is on.



① Place the container on the platter.

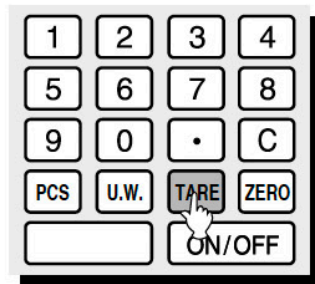

② Press the TARE key.

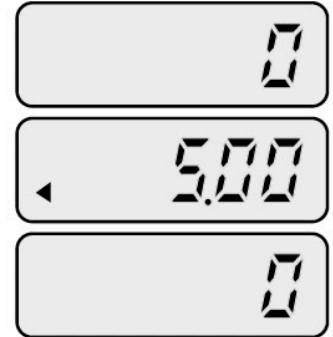

③ Place the sample in the container. Then the weight display will show only weight of the sample.

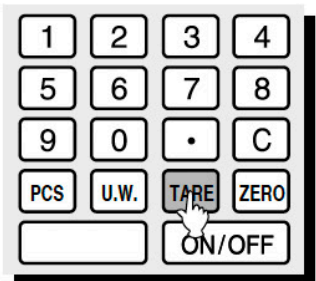
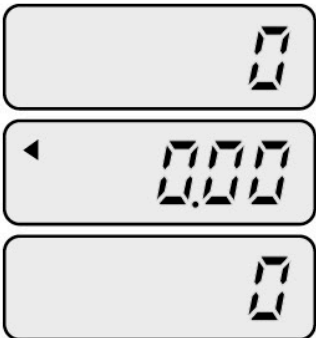

④ Remove the container and press the TARE key.

B) Known Tare

- If you know the weight of the container you may use this method.
- Make sure that ZERO lamp is on.

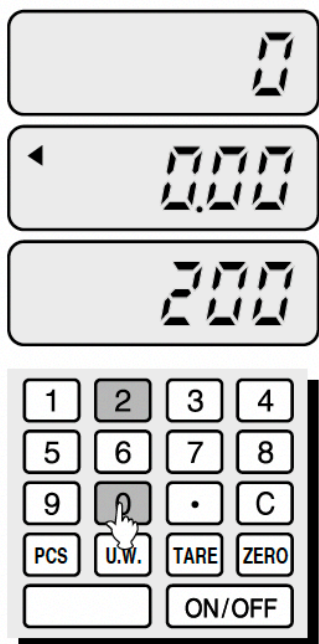

① Enter the weight of the container.

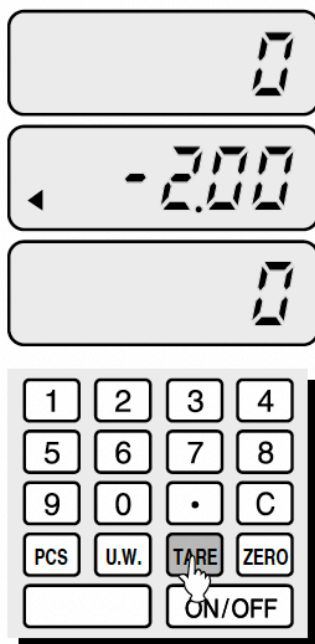

② Press the TARE key.
Then you will see the weight of the container.

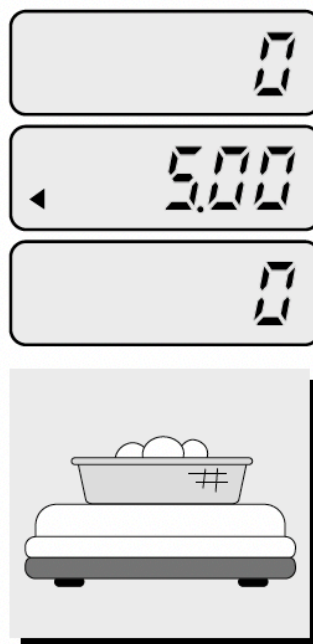

③ Place the sample with container on the platter.

►NOTE: If the weight of the container is 2kg, you have to type 200 (①).
Because the weight of the container displayed as 2.00kg in the weight display (②). If the weight of the container is 900g, you have to type 90, then the weight display shows the 0.90kg(900g).

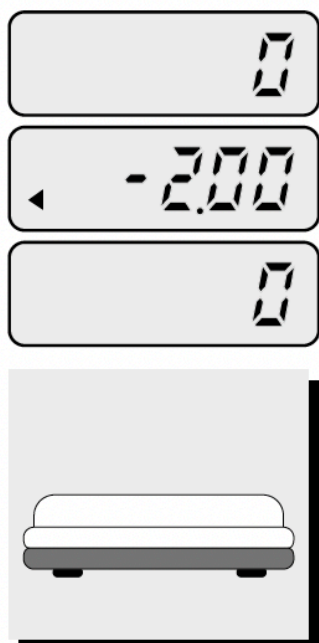

④ Remove the sample with container from the platter.

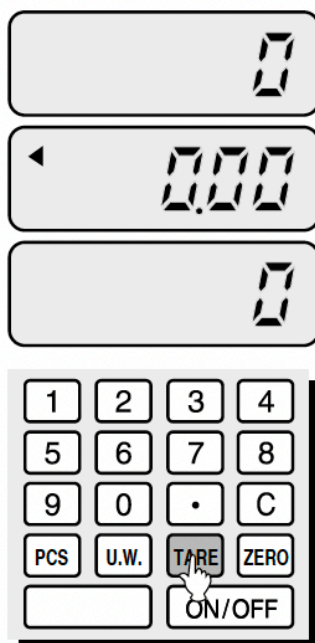

⑤ Press the TARE key.

TABLE 1. Range of the Tare Weight

MODEL	MAX. WEIGHT	MAX. TARE WEIGHT	MIN. WEIGHT
25AC	25kg	9.995kg	5g
50AC	50kg	19.99kg	10g
100AC	100kg	39.98kg	20g

5. Computing Error Alarm

This scale has an alarm function for the samples that are either very small or very light. This function shows the possibility of calculating errors.

Sample Weight Lack Alarm

- If the sample weight is within the range of sample weight lack, (Refer to TABLE 2) Lack of Sample lamp will be flickered.

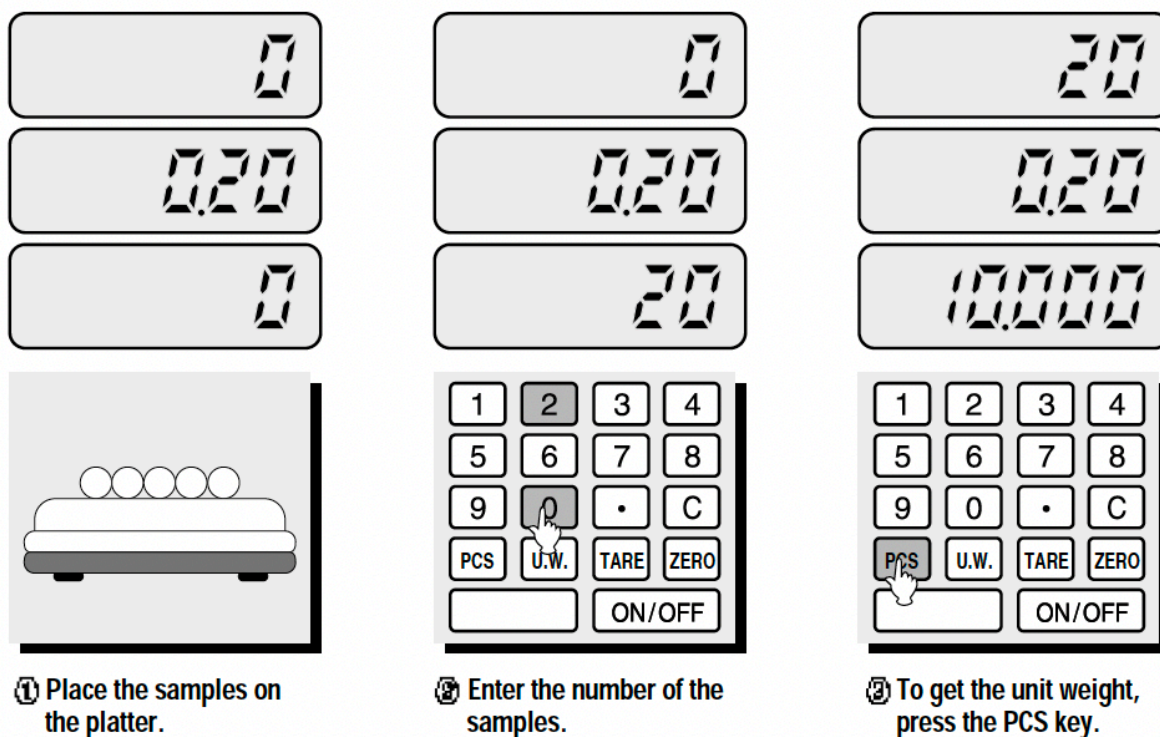

For example, if this scale is 50AC, 0.2kg(200g) is within the range of sample lacking. (Refer to TABLE 2) In this case, Lack of Sample lamp will be flickered.

Until the flickering disappears, increase the sample weight.

Then unit weight can be changed and the number of samples will be calculated automatically.

- NOTE: If the counting number exceed the "99,999", then the number display shows "-----", and you will hear a beep sound.

Unit Weight Lack Alarm

- If unit weight is within the range of unit weight lack, Lack of U/W lamp will be flickered. (Refer to TABLE 2)

TABLE 2. Range of the Tare Weight

MODEL	MAX. WEIGHT	RANGE OF SAMPLE WEIGHT LACK	RANGE OF UNIT WEIGHT LACK
25AC	25kg	0 – 125g	0 – 2.5g
50AC	50kg	0 – 250g	0 – 5g
100AC	100kg	0 – 500g	0 – 10g

SPECIFICATIONS

MODEL	25 AC	50 AC	100 AC
CAPACITY	25kg × 5g	50kg × 10g	100kg × 20g
MAX. TARE WEIGHT	9.995kg	19.99kg	39.98kg
SAMPLE LACKING	0 – 125g	0 – 250g	0 – 500g
UNIT WEIGHT LACKING	0 – 2.5g	0 – 5g	0 – 10g
FUNCTION	PCS, U.W., TARE, ZERO		
DISPLAY DIGIT	5 / 5 / 5		
TEMPERATURE RANGE	-10°C ~ +40°C		
POWER SOURCE	AC 220V / 50Hz		
POWER CONSUMPTION	APPROX. 10W		
PRODUCT SIZE	420(W) × 615(D) × 968(H)		
PRODUCT WEIGHT	APPROX. 17kg		

- Notice: Specifications are subject to change for improvement without notice.

MEMO

